

CE DECLARACION DE CONFORMIDAD

Como Manufacturero:

Monarch Instrument

Division of Monarch International Inc.
15 Columbia Drive, Amherst NH 03031 USA

declara bajo responsabilidad única de Monarch que este producto:

Pocket Tach 99

a que esta declaración relaciona está en la conformidad con los estándares siguientes:

EMC: EN61326:1997 /A1:1998/A2:2001/A3:2003 Class A

Seguridad Láser: IEC60825-1

Seguridad eléctrico: IEC61010-1:2001-2

y por lo tanto se conforma con los requisitos de relacionar de Directriz 2004/108/EG de Concilio a la compatibilidad electromagnéticos y 2006/95/EC que relacionan a la directriz baja del voltaje cuando operado de acuerdo con la guía del usuario.

Referencia: Retlif Testing Laboratories, (Report No. R-4283N)
Technical Construction File PLT-0704 del Julio del 2004

15th de Enero del 2010
Manufacturero (Amherst,NH)

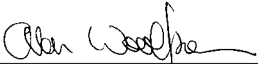
Alan Woolfson, VP Ingenieria (Firma autorizada)

Impreso en EE.UU.

Copyright 2010 Monarch Instrument, todo derecho reservado

MONARCH INSTRUMENT

Instruction Manual



Pocket Tach 99 (PT99)

**Non-Contact Tachometer
Tachymètre sans Contact
Tacómetro sin Contacto**

15 Columbia Drive
Amherst, NH 03031 USA
Phone: (603) 883-3390
Fax: (603) 886-3300

E-mail: support@monarchinstrument.com
Website: www.monarchinstrument.com

SAFEGUARDS AND PRECAUTIONS



WARNING - This product emits a visible beam of red LED light. Avoid exposure. The use of optical viewing aids (binoculars, for example) may increase the ocular hazard. (This is not a laser product.)

CAUTION - The red LED beam should not be intentionally aimed at people or animals.



Read and follow all instructions in this manual carefully, and retain this manual for future reference.

Do not use this instrument in any manner inconsistent with these operating instructions or under any conditions that exceed the environmental specifications stated.

This instrument is not user serviceable. For technical assistance, contact the sales organization from which you purchased the product.



In order to comply with EU Directive 2002/96/EC on Waste Electrical and Electronic Equipment (WEEE): This product may contain material which could be hazardous to human health and the environment. DO NOT DISPOSE of this product as unsorted municipal waste. This product needs to be RECYCLED in accordance with local regulations, contact your local authorities for more information. This product may be returnable to your distributor for recycling - contact the distributor for details.

Monarch Instrument's Limited Warranty applies. See www.monarchinstrument.com for details.

Warranty Registration and Extended Warranty coverage available online at www.monarchinstrument.com.

8.0 OPCIONES /ACCESORIOS

T-5	Rollo de Cinta Reflectiva de 5 pies [1.5 m] roll, ½ pulgada [13 mm] de ancho
CC-10	Estuche de nailon protector
CC-11	Estuche con cerradura para <i>Pocket Tach</i> y accesorios
CAL-N.I.S.T.	N.I.S.T. Certificado de Calibración verificable

6.0 BATERÍAS

Cuando se indica, cambie las baterías.

Remueva la tapa del compartimiento de batería

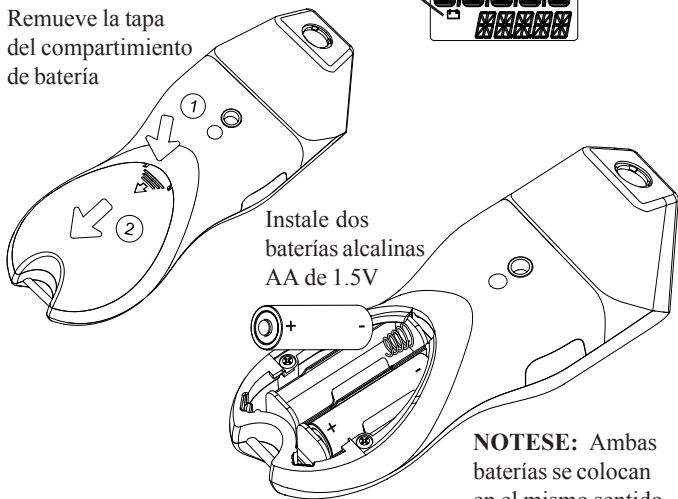

Instale dos
baterías alcalinas
AA de 1.5V

NOTESE: Ambas
baterías se colocan
en el mismo sentido.

TABLE OF CONTENTS

1.0	OVERVIEW	E-1
2.0	FEATURE LOCATIONS	E-1
3.0	LCD DISPLAY SYMBOLS	E-2
4.0	PT99 SPECIFICATIONS	E-3
5.0	NON-CONTACT MEASUREMENTS	E-4
5.1	Preparation for Measurement	E-4
5.2	Setup	E-5
5.3	Operation	E-6
6.0	BATTERIES	E-7
7.0	CLEANING	E-7
8.0	OPTIONS / ACCESSORIES	E-8

7.0 LIMPIEZA

Para limpiar el instrumento, pase un trapo húmedo usando una solución suave de jabón.

1.0 OVERVIEW

The Pocket Tach 99 is a hand-held precision optical tachometer designed to make non-contact measurements of rotational speeds from 5 to 99,999 RPM at a distance of up to 36 inches (91.44 cm) from a reflective target and at an angle of up to 30° off perpendicular. The unit has the ability to recall maximum and minimum values. The unit can be tripod mounted and locked on for continuous measurements.

2.0 FEATURE LOCATIONS

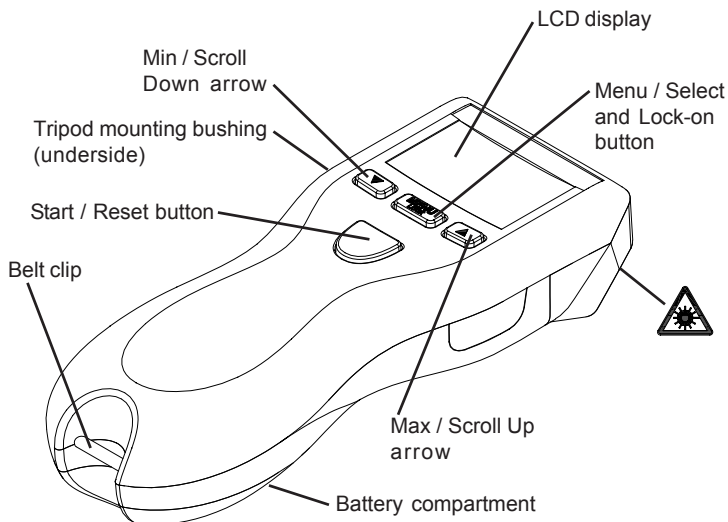

CAUTION - Red LED light emitted from this aperture. (This is not a laser product.)

5.3 Operación

Medir



Mantenga presionado

Fijar (Lock-on)

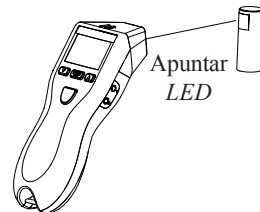

Llamar valor
Máximo
guardado



Velocidad Máximo
MAX

Llamar valor
Mínimo
guardado



Velocidad Mínima
MIN

Si la unidad
esta fijada en
modo
continuo:



Reinicia Max/Min

Apagar



Se apaga automáticamente
después de 90 segundos si
la unidad no esta fijada en
modo continuo

5.2 Arreglo

1. Encender la unidad
 

- 1a. Para cambiar entre modo Fijo y no Fijo Mantenga presionado el boton
 

2. Entre modo Setup (selección de posición de decimal)
 

NONE, 1, 2 o 3

3. Seleccione posiciones decimales
 

Repita hasta el número de posiciones decimales se despliega

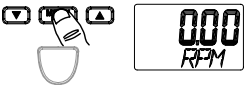
4. Guarde y salga – Listo para medir
 

RPM demostró con número seleccionado de posiciones de decimales

La unidad guardará estos parametros para uso futuro (incluyendo Fijar modo continuo, *Lock on/off*) aún si se apaga y se vuelve a prender.

3.0 LCD DISPLAY SYMBOLS

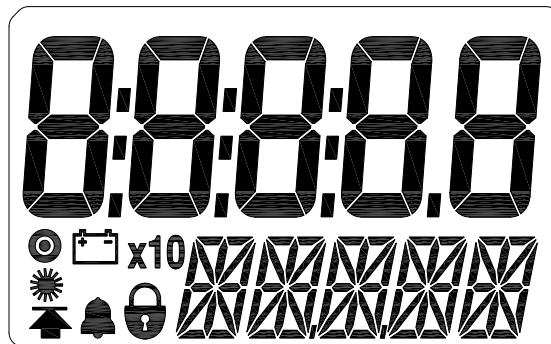

-  On Target indicator. Blinks on whenever there is an input signal. Will appear to be solid on at higher frequencies.

-  Low Battery icon. Indicates that the batteries are low and need to be replaced.

- x10** Times Ten icon. Indicates that the value shown is ten times that which is displayed.

-  **LED Indicator. Red LED is on when this indicator is illuminated.**

-  Lock icon. Indicates that the unit is “Locked” on and making continuous measurements (Lock-on mode).

4.0 PT99 SPECIFICATIONS

Speed Range: 5 to 99,999 RPM

Accuracy: $\pm 0.01\%$ of reading or ± 1 digit

Resolution: 0.001 RPM to 1 RPM

Operating Range: 36" (91.44 cm) up to 30 degrees off perpendicular

Display: 5 Digits, 5 Alpha-numeric LCD

Light Source: Red LED

Batteries: 2 "AA" 1.5 V  (DC) alkaline included
(Note: Batteries are NOT rechargeable)

Battery Life: 60 hours continuous typical with provided batteries

Dimensions: 6.92" (17.58 cm) H x 2.4" (6.10 cm) W x 1.6" (4.06 cm) D

Weight: approx. 7 oz. (210 g)

This product is designed to be safe for indoor use under the following conditions (per IEC61010-1).

Installation Category II per IEC 664

Pollution Degree Level II per IEC 664

Temperature: 40 °F to 105 °F (5 °C to 40 °C)

Humidity: Maximum relative humidity of 80% for temperatures up to 88 °F (31 °C) decreasing linearly to 50% relative humidity at 100 °F (40 °C). Humidity non-condensing.

Specifications subject to change without notice.

5.0 MEDIDAS SIN CONTACTO

5.1 Preparación para la Medida

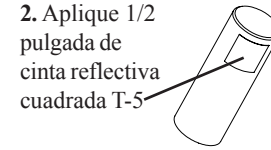

Para barras pequeñas:

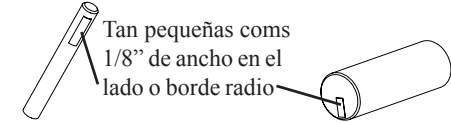

4.0 ESPECIFICACIONES DEL PT99

Velocidad Gama: 5 a 99,999 RPM

Exactitud: $\pm 0.01\%$ de la lectura o ± 1 dígito

Resolución: 0.001 RPM a 1 RPM

Operar Gama: 36" (91.44 cm) hasta 30 grados de perpendicular

Despliegue: 5 dígitos numéricos más 5 alfanumérico *LCD*

Fuente ligera: Rojo *LED*

Baterías: 2 "AA" 1.5 V  (CC) alcalinos incluidas
(Notese: Baterías NO se pueden volver a cargar.)

Vida de Batería: típicamente 60 horas continuas con las baterías suministrados

Dimensiones: 6.92" (17.58 cm) de alto x 2.4" (6.10 cm) de ancho x 1.6" (4.06 cm) de profundo

Peso: Aprox. 7 onzas. (210 g)

Este producto fue concebido para ser segura para uso interno bajo las siguientes condiciones (según IEC61010-1).

Categoría de instalación II según IEC 664

Grado de nivel de contaminación II según IEC 664

Temperatura: 40 °F a 105 °F (5 °C a 40 °C)

Humedad: Humedad relativa maxima de 80% para temperatures hasta 88 °F (31 °C) disminuyendo linealmente hasta un 50% de humedad relativa a una temperatura de 100 °F (40 °C).
Humedad sin condensar.

Especificaciones sujetos a cambios sin aviso previo.

5.0 NON-CONTACT MEASUREMENTS

5.1 Preparation for Measurement



2. Apply 1/2 inch (12.7 mm) square T-5 Reflective tape

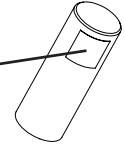



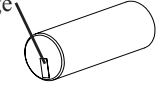
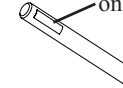

For Small Shafts:

As small as 1/8 inch (3.2 mm) wide on side or radius edge

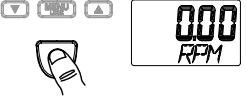

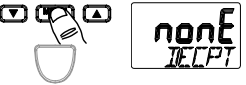

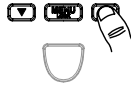
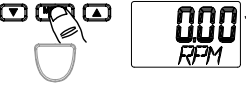

5.2 Setup

1. Turn Power ON

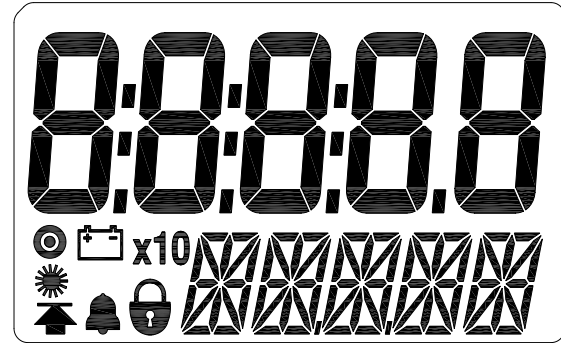
- 1a. To toggle Lock On/Off
Press and Hold

2. Enter Setup (decimal place selection)
 NONE, 1, 2 or 3
3. Select decimal places
 OR  Repeat until desired decimal places displayed
4. Save and exit – Ready to measure
 RPM displayed with selected number of decimal places

Unit will remember these settings (including lock on/off) even if turned off and back on.

3.0 SIMBOLOS LCD DE DESPLIEGUE



-  Indicador de posición correcta (*On Target*). Parpadea siempre y cuando hay una señal de entrada. Aparenta ser solida en frecuencias altas.
-  Indicador de batería baja. Indica que las baterías estan por agotarse y tienen que ser cambiadas.
- x10** Indicador Por Diez. Indica que el valor medido es diez veces el valor indicado.
-  **Indicador LED. Rojo LED está en cuando este indicador es iluminado.**
-  Indicador Fijar modo continuo. Indica que la unidad esta en modo Fijo y esta haciendo medidas continuas.

1.0 VISTA GENERAL

El *Pocket Tach 99* son una precisión de mano tacómetro que óptico diseño para hacer medidas de no-contacto de velocidades giratorias de 5 a 99.999 RPM a una distancia de hasta 36 pulgadas (91,44 cm) de un objetivo reflector y en un ángulo de hasta 30° de perpendicular. La unidad tiene la capacidad de recordar valores de máximo y mínimo. La unidad puede ser trípode montada y “Locked-on” para medidas continuas.

2.0 UBICACION DE FUNCIONES

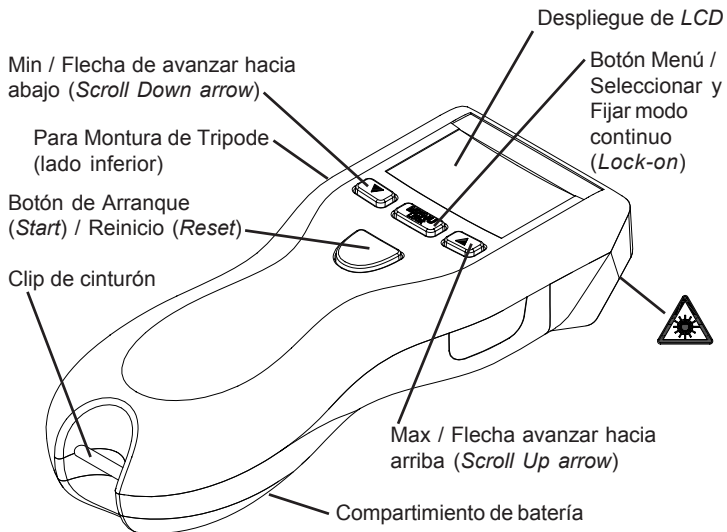

ADVIERTA - la luz LED Roja emitió de este aperture. (Esto no es un producto de láser).

5.3 Operation

Measure



Press and hold



Lock on

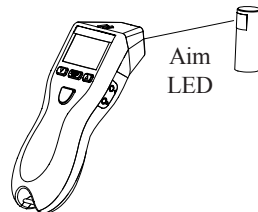

Recall Max



Max Speed

Recall Min



Min Speed

If unit Locked on:



Resets Max/Min

Power OFF



OR Automatic after 90 seconds if unit not Locked on

6.0 BATTERIES

When displayed, replace batteries.



Remove battery cover

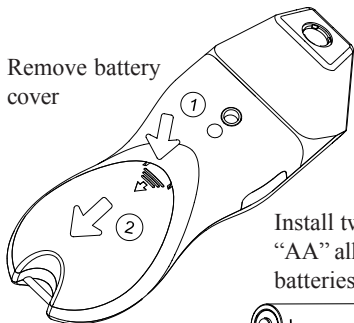

Install two 1.5V
"AA" alkaline
batteries

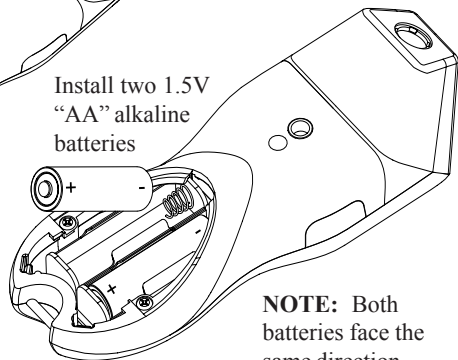

NOTE: Both
batteries face the
same direction.

7.0 CLEANING

To clean the instrument, wipe with a damp cloth using mild soapy solution.

TABLA DE CONTENIDO

1.0 VISTA GENERAL	S-1
2.0 UBICACION DE FUNCIONES	S-1
3.0 SIMBOLOS <i>LCD</i> DE DESPLIEGUE	S-2
4.0 ESPECIFICACIONES DEL PT99	S-3
5.0 MEDIDAS SIN CONTACTO	S-4
5.1 Preparación para la Medida	S-4
5.2 Arreglo	S-5
5.3 Operación	S-6
6.0 BATERÍAS	S-7
7.0 LIMPIEZA	S-7
8.0 OPCIONES / ACCESORIOS	S-8

CUIDADOS Y PRECAUCIONES



AVISO - Este producto emite un rayo visible de la luz roja LED. Evite exposición. El uso de aparatos para ayudar a la vista (por ejemplo, binoculares) puede aumentar el peligro a los ojos. (Esto no es un producto de láser.)

PRECAUCION - El rayo rojo LED no debe ser intencionalmente apuntado ni a las personas ni a los animales.



Lee y siga las instrucciones en este manual cuidadosamente, y retenga este manual para referencia futura.

No use este instrumento de cualquier manera que no sea consistente con estas instrucciones de operación ni bajo cualquier condición que exceda las especificaciones ambientales estipuladas.

El usuario no puede dar servicio a este instrumento. Para asistencia técnica, contacte la organización de venta donde compró el producto.



Para obedecer con EU Directiva 2002/96/EC en el Desecho el Equipo Eléctrico y Electrónico (WEEE): Este producto puede contener la materia que podría ser la salud humana perjudicial para y el ambiente. NO se DESHAGA de este producto el desecho municipal como no clasificado. Estas necesidades del producto para SER RECICLADAS de acuerdo con las regulaciones locales, contactan su administración local para más información. Este producto puede ser retornable a su distribuidor para reciclar - contacta el distribuidor para detalles.

La Garantía Limitado de Monarch Instrument se aplica. Vea www.monarchinstrument.com para los detalles.

Registro de la cobertura de Garantía Extendida es disponible a través del internet al www.monarchinstrument.com.

8.0 OPTIONS / ACCESSORIES

T-5	Reflective Tape, 5 foot [1.5 m] roll, ½ inch [13 mm] wide
CC-10	Padded Nylon Carrying Case
CC-11	Latching Carrying Case for Pocket Tach and accessories
CAL-N.I.S.T.	N.I.S.T. Traceable Certificate of Calibration

CE DECLARATION OF CONFORMITY

As Manufacturer:

Monarch Instrument

Division of Monarch International Inc.
15 Columbia Drive, Amherst NH 03031 USA

declares under Monarch's sole responsibility that the product:

Pocket Tach 99

to which this declaration relates is in conformity with the following standards:

EMC: EN61326:1997 /A1:1998/A2:2001/A3:2003 Class A

Laser Safety: IEC60825-1:2001

LVD: EN61010-1:2001-2

and therefore conforms with the requirements of Council Directive 2004/108/EG relating to electromagnetic compatibility and 2006/95/EC relating to the low voltage directive when operated in accordance with the user manual.

References: Retlif Testing Laboratories, (Report No. R-4283N)
Technical Construction File PLT-0704 of July 2004

15th January 2010

Manufacturer (Amherst, NH)

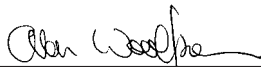

Alan Woolfson, VP Engineering (Authorized Signature)

Printed in the U.S.A.

Copyright 2010 Monarch Instrument, all rights reserved

MONARCH INSTRUMENT

Manual de Instrucción



Pocket Tach 99 (PT99)

Tacómetro sin Contacto

15 Columbia Drive
Amherst, NH 03031 USA

Tel: (603) 883-3390

Fax: (603) 886-3300

E-mail: support@monarchinstrument.com

Internet: www.monarchinstrument.com



DÉCLARATION DE CONFORMITÉ CE

Comme manufacturier:

Monarch Instrument

Division of Monarch International Inc.
15 Columbia Drive, Amherst NH 03031 USA

déclare sous la responsabilité de Monarch seulement que le produits:

Pocket Tach 99

à lequel cette déclaration relate est dans la conformité avec les normes suivantes:

EMC: EN61326:1997 /A1:1998/A2:2001/A3:2003 Class A

Laser Safety: IEC60825-1:2001

LVD: EN61010-1:2001-2

et par conséquent conforme aux exigences définies par la Directive du Conseil 2004/108/EG relative à la compatibilité électromagnétique et à la Directive 2006/95/EC relative à la directive sur les faibles tensions lorsqu'il est utilisé conformément aux conditions définies dans le manuel d'utilisation.

References: Retlif Testing Laboratories, (Report No. R-4283N)
Technical Construction File PLT-0704 of July 2004

15th January 2010

Manufacturier (Amherst,NH)

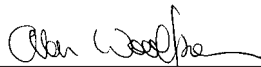

Alan Woolfson, VP Engineering (Authorized Signature)

Imprimer aux États-Unis

Droits d'auteurs 2010 Monarch Instrument, tous droits réservés

MONARCH INSTRUMENT

Manuel d'instructions



Pocket Tach 99 (PT99) Tachymètre sans Contact

15 Columbia Drive
Amherst, NH 03031 USA
Téléphone: (603) 883-3390
Facsimile: (603) 886-3300

Courriel: support@monarchinstrument.com
Site Web: www.monarchinstrument.com

PRÉCAUTIONS ET SÉCURITÉS



AVERTISSEMENT - Ce produit émet un rayon de lumière rouge qui est visible à l'œil. Si vous utilisez des jumelles ou autre aides de vue vous augmenter le danger a vos yeux. (Ceci n'est pas un produit laser.)

PRÉCAUTION - Le rayon de lumière rouge ne devrait pas être intentionnellement visé aux gens ou aux animaux.



Lie et suit toutes instructions dans ce manuel soigneusement, et retiens ce manuel comme référence.

Utiliser cet instrument seulement sous les conditions spécifier dans ce manuel.

Cet instrument n'est pas réparable par l'utilisateur. Pour assistance technique, contacter le fournisseur du produits.



Afin de respecter la directive européenne 2002/96/EC sur l'Équipement Electronique et les Déchets Electriques: Ce produit pourrait contenir des matières qui peuvent être dangereuses pour la santé de l'homme et de l'environnement. Ne pas jeter ce produit dans un

conteneur municipal inapproprié. Ce produit doit être recyclé en accord avec les arrêtés locaux; contacter les autorités locales pour plus de renseignements. Ce produit peut être renvoyé au distributeur pour recyclage - Contacter votre distributeur pour plus de details.

La Garantie de Monarch Instrument s'applique. Voir www.monarchinstrument.com pour les détails.

L'Enregistrement de Garantie et la couverture de Garantie Prolongée disponible à www.monarchinstrument.com.

8.0 OPTIONS / ACCESSOIRES

T-5	Ruban réfléchissant, rouleau de 5 pieds [1.5 m], 1/2 pouces [13 mm] de large
CC-10	Étuis en Nylon
CC-11	Étuis pour Pocket Tach et accessoires
CAL-N.I.S.T.	Certificats d'étalonnage retraceable a N.I.S.T

6.0 PILES

Indique piles faibles.



Enlever le couvret
des piles

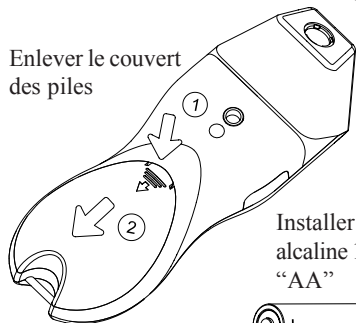

Installer 2 piles
alcaline 1.5V
"AA"

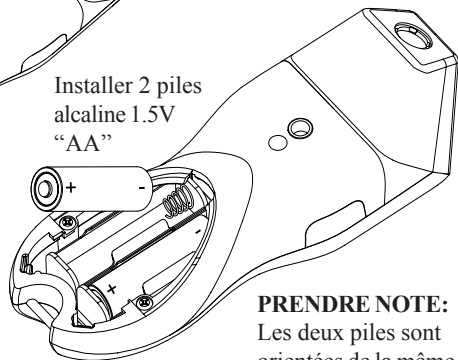

PRENDRE NOTE:
Les deux piles sont
orientées de la même
manière.

7.0 NETTOYAGE

Pour nettoyer l'instruments, essuyer avec un tissu humide utilisant une solution savonneuse.

TABLE DES MATIÈRES

1.0	SURVOL	F-1
2.0	EMPLACEMENTS DE CARACTÉRISTIQUE	F-1
3.0	REPRÉSENTATION DES SYMBOLES	F-2
4.0	SPÉCIFICATIONS DU PT99	F-3
5.0	LECTURES SANS CONTACT	F-4
5.1	Préparation pour Lecture	F-4
5.2	Mise en marche	F-5
5.3	Opération	F-6
6.0	PILES	F-7
7.0	NETTOYAGE	F-7
8.0	OPTIONS / ACCESSOIRES	F-8

1.0 SURVOL

Le Pocket Tach 99 est un tachymètre optique à haute précision conçu pour faire des mesures sans-contact de vitesses de rotation de 5 à 99,999 RPM jusqu'à une distance de 36 pouces (91,44 cm) d'une cible réfléchissante et à des angles jusqu'à 30° de la perpendiculaire. L'unité a la capacité à mémoriser les valeurs maximale et minimale. L'unité peut être montée sur un trépied et serrée pour des mesures continues.

2.0 EMBLEMES DE CARACTÉRISTIQUE

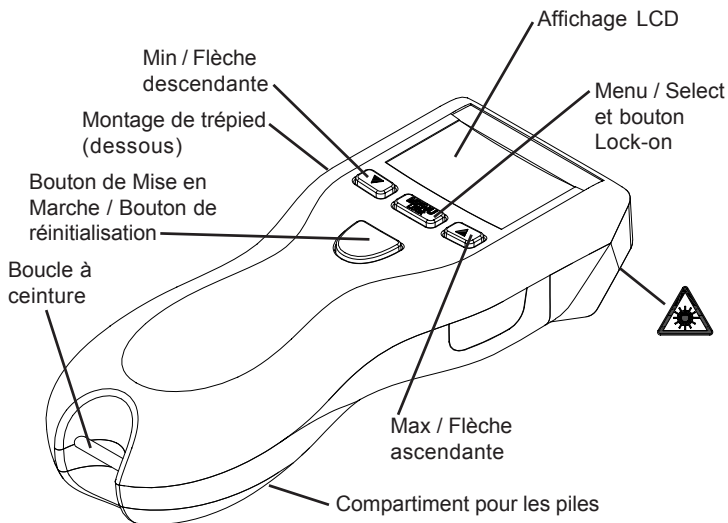

MISE EN GARDE - Une lumière rouge est émise par ce produit. (Ceci n'est pas un produit laser.)

5.3 Opération

Prend lecture    OU   



Appuyer et retenir



Lock on

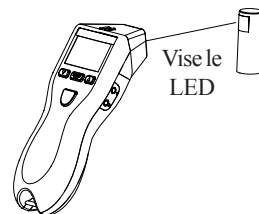

Voir Max



Vitesse maximale

Voir Min



Vitesse minimale

Si l'appareil est en mode Lock on:





Efface Max/Min

Arrêt de l'appareil



OU Arrêt automatique après 90 secondes si l'appareil n'est pas en mode Lock on

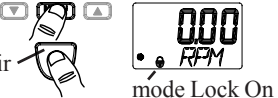

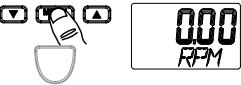

5.2 Mise en marche

1. Alimenter l'instrument

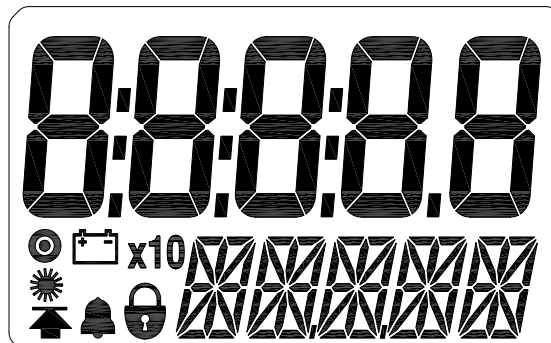
- 1a. Bascule entre Lock On/Off
Appuyer et retenir

2. Entrée mode SETUP (pour choisir place décimal)
 *NONE*(aucun), 1, 2 ou 3
3. Choisie la place décimale
 Répète pour choisir la place décimale désiré
4. Sauve garder et sortir - Prêt a prendre des lectures
 RPM afficher avec nombre de places décimal choisi

L'appareil se rappelle de sont paramétrage (Lock On/Off incluses) même si il pers son alimentation.

3.0 REPRÉSENTATION DES SYMBOLES



-  Indicateur de la cible. Clignote lorsqu'il detect un signal d'entré. Apparaît à être toujours allumé à plus haute fréquence.
-  Indicateur de piles faibles. Indique que les piles sont faible et devrait être remplacer.
- x10** Icon fois dix. Indique que la valeur est dix fois plus de ce qui est affiché.
-  **Indicateur du LED. Le LED rouge est allumé quand cet indicateur est illuminé.**
-  Lock Icon. Indique que l'unité faisant des mesures continues (mode Lock On).

4.0 SPÉCIFICATIONS DU PT99

Gamme de vitesse: 5 à 99,999 RPM

Précision: $\pm 0.01\%$ de la lecture ou ± 1 digit

Résolution: 0.001 RPM à 1 RPM

Gamme d'opération: 36" (91.44 cm) jusqu'à 30° du perpendiculaire

Affichage: 5 Digits, 5 Alpha-numérique LCD

Source du lumière: LED Rouge

Piles: 2 "AA" 1.5 V  (CC) alcaline incluses
(Les piles ne sont pas rechargeable.)

Durée de vie de les piles: 60 heures d'usage continues

Dimensions: 6.92" (17.58 cm) H x 2.4" (6.10 cm) L x 1.6" (4.06 cm) L

Poids: 7 oz. (210 g) aproximatif

Ce produit est fabriqué pour être utiliser a l'intérieur sous les conditions suivantes. (IEC61010-1)

Catégorie d'installation II per IEC 664

Niveaux de pollution II per IEC 664

Température: 40 °F à 105 °F (5 °C à 40 °C)

Humidité: Humidité relative maximale de 80% pour température jusqu'à 88 °F (31 °C) diminuant à 50% humidité relative à 100 °F (40 °C). Humidité non condenser.

Spécifications peuvent être changé sans avertissement.

5.0 LECTURES SANS-CONTACT

5.1 Préparation pour Lecture

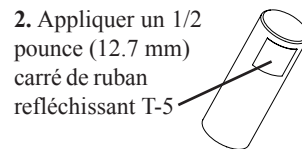
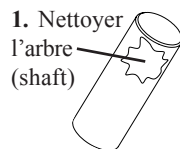

Pour arbre plus petit:

