



# **VG5 FMCW RADAR FOR LIQUIDS, SLURRIES AND PASTES**

# RADAR TECHNOLOGY FOR LEVEL MEASUREMENT

## INSENSITIVE TO CHANGES IN

- ◆ Dielectric
- ◆ Pressure
- ◆ Vacuum
- ◆ Humidity
- ◆ Dust
- ◆ Viscosity
- ◆ Foam
- ◆ Temperature

## THE ADVANTAGES ARE

- ◆ Measuring ranges up to 30m
- ◆ Versatile technology for Liquids, Slurries & Pastes.
- ◆ Display of Level, Distance or Volume
- ◆ 2 wire loop powered 24vdc
- ◆ Hazardous area ATEX, IECEx, EExd, EExia, cFMus, CRN
- ◆ HART, Profibus (PA) and Foundation Fieldbus
- ◆ Suitable for narrow tanks with minimum fixed beam diameter.
- ◆ Simple to install and retrofit with wide range of process connections
- ◆ Suitable for corrosive and acidic atmospheres
- ◆ High temperature and pressure options are available
- ◆ Remote or local programming and configuration
- ◆ Suitable for detecting levels through surface foam
- ◆ Sealed Flange system maintains system integrity for removal
- ◆ SIL 2 approval for critical applications.
- ◆ Low cost competitive level measurement
- ◆ Advanced signal analysis
- ◆ Stirrer and tank obstruction avoidance software
- ◆ Small process entry antenna options
- ◆ Programmable from ground level no climbing of tanks required
- ◆ Horizontal or vertical housing mounting options
- ◆ Quick release housing couplings for ease of service

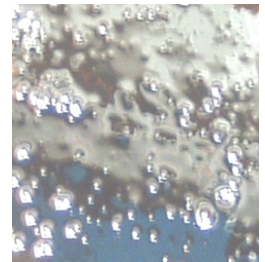

Acids



Waste



Water



Pastes

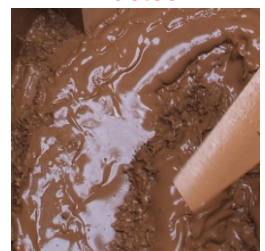

Slurry

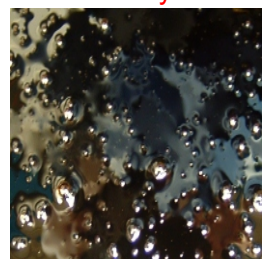

Oils

## SUITABLE FOR ALL INDUSTRIES

- ◆ Petrochemical
- ◆ Food
- ◆ Chemical
- ◆ Paint
- ◆ Water & Waste
- ◆ Cement
- ◆ Asphalt
- ◆ Minerals
- ◆ Power Generation
- ◆ Steel
- ◆ Quarrying
- ◆ Powder

## RADAR FOR A VARIETY OF APPLICATIONS

- ◆ Level Measurement
- ◆ Volume Measurement
- ◆ Distance Measurement
- ◆ Flow measurement

## COST EFFECTIVE REPLACEMENT FOR

- ◆ Capacitance transmitters
- ◆ Hydrostatic transmitters
- ◆ Differential pressure transmitters
- ◆ Displacers
- ◆ Ultrasonics
- ◆ Pulse systems
- ◆ Laser transmitters

# REFLEX VG5 SERIES FMCW RADAR

A radar signal is generated via an antenna and transmitted down the vessel or tank which is then reflected by the target surface and received back at the antenna.

The VG5 FMCW radar uses a high frequency signal, nominal 10Ghz which increases linearly during the measurement (frequency sweep) . The signal is emitted, reflected from the target surface and received at a time-delayed frequency.

The difference in this frequency is calculated from the actual transmit frequency and the receive frequency and this difference is directly proportional to the distance measured.

**Advantages of VG5 FMCW principle compared to other radar technologies:**

- ◆ Better reflection separation
- ◆ Reliable noise reduction
- ◆ Smaller beam angle
- ◆ High signal reflection
- ◆ Smaller antenna diameter for same measuring range



## THE ADVANTAGES OF FMCW RADAR

**NON-CONTACT LEVEL MEASUREMENT**

**SUITABLE FOR AGGRESSIVE MEDIA**

**MEASURES LIQUIDS, SLURRIES and PASTES**

**RANGE UP TO 30 METRES**

**HIGH ACCURACY OPTIONS AVAILABLE**

**VESSEL MAPPING REMOVES SPURIOUS SIGNALS**

**TBF MODE AVAILABLE FOR LOW DIELECTRIC PRODUCTS**

**UNAFFECTED BY PRESSURE, TEMPERATURE, VISCOSITY, FOAM OR DUST**

**AVAILABLE WITH HORN WAVE GUIDE AND NEW PATENTED WAVEHORN**

**MULTIPLE ATEX OPTIONS AND SIL2 FOR HI/ LOW DEMAND OPERATION**

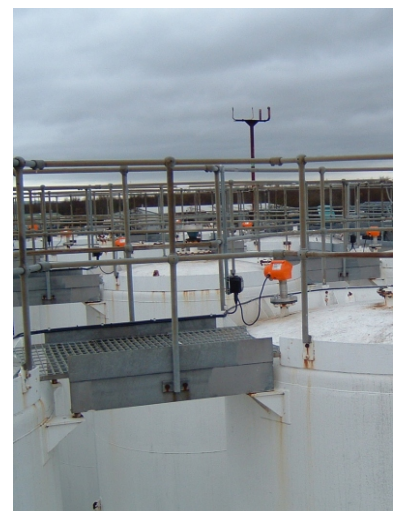

# DISPLAY AND PROGRAMMING

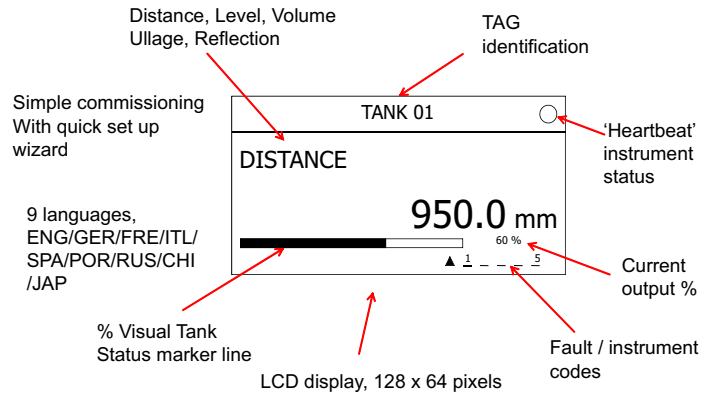

The display can be ordered with the device or as an accessory for programming later. This provides a cost saving if you have multiple units but do not require a display on the tank top but would like the flexibility of being able to program the units without a laptop. The display screen is 128 x 64 pixels and the programming of the instrument is all via a simple four push button keypad which is menu driven..

The unit is designed to be programmed for simple applications without the need for a detailed manual enabling a fast set and commissioning.

The display is available in nine different languages and displays tank ID data, the level or distance, fault codes and percentage full bars



## FLEXIBLE REMOTE DISPLAY OPTIONS

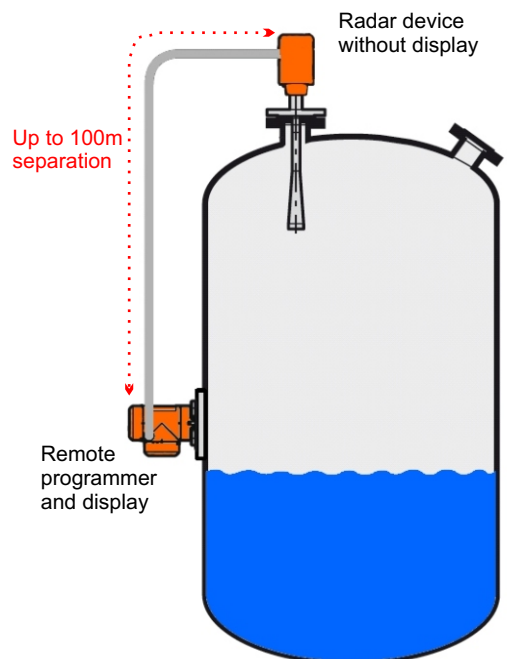
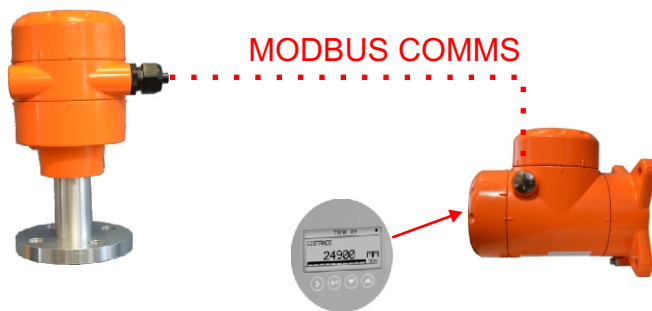

With this option operators can now read the tank level measurements from ground level and configure the device without having to climb to the top of the tank. This saves time, reduces maintenance and reduces the risk of slips trips and falls from height. The remote converter can be installed up to 100 m / 328 ft away from the process connection on the tank.

The remote housing can be attached to a wall, pipe or rigid surface with the supplied wall support mounting bracket.

# FLEXIBLE FMCW RADAR

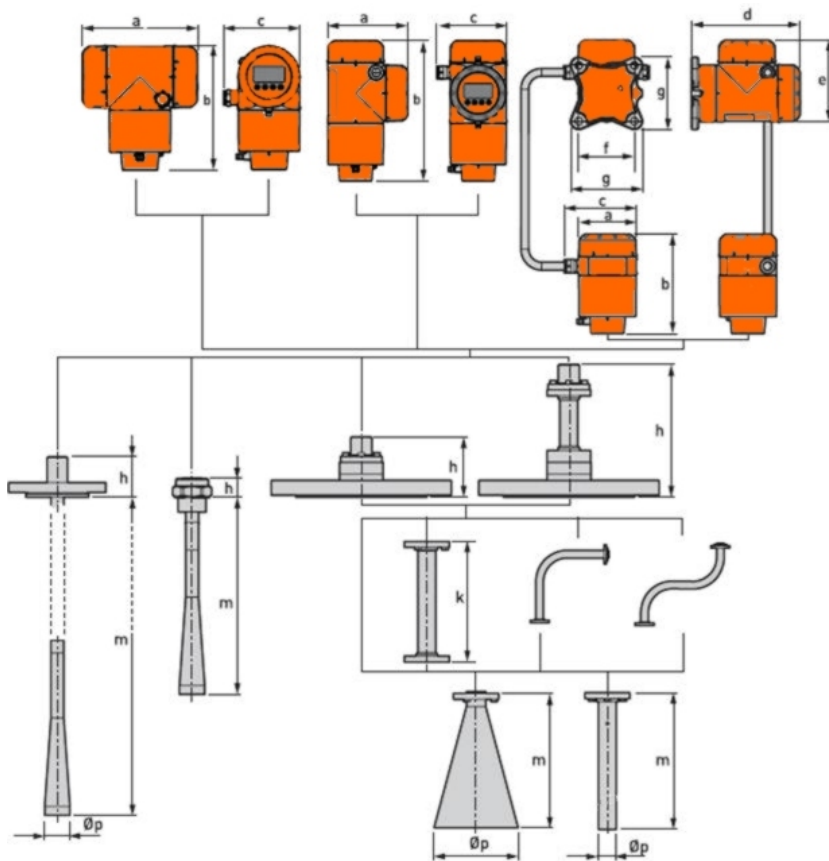

## Housing, process connection and antenna options

1. Housing options. From left to right: compact converter with horizontal housing, compact converter with vertical housing, and remote converter (top) and antenna housing (bottom)

2. Process connection options. From left to right: flange connection for PTFE Wave Horn antenna, threaded connection for PP Wave Horn antenna, flange connection for Metallic Horn and Wave Guide antennas, flange connection with a high-temperature (HT) extension for Metallic Horn and Wave Guide antennas

3. Antenna options. From left to right: PTFE Wave Horn antenna, PP Wave Horn antenna, Metallic Horn antenna (with or without an antenna extension option: straight, "L" or "S" extension), Wave Guide antenna. All housing covers have bayonet connectors unless it is an explosion-proof (XP / Ex d-approved) device. The terminal compartment cover

Dimensions	Compact - horizontal		Compact - vertical		Remote	
	Non-Ex or Ex i (Ex d)		Non-Ex or Ex i (Ex d)		Non-Ex or Ex i (Ex d)	
	[mm]	[inches]	[mm]	[inches]	[mm]	[inches]
a	191 (258)	7.5 (10.2)	147 (210)	5.79 (8.27)	104 (104)	4.09 (4.09)
b	214 (214)	8.43 (8.43)	258 (258)	10.16 (10.16)	181 (181)	7.13 (7.13)
c	127 (127)	5.00 (5.00)	127 (127)	5.00 (5.00)	129 (129)	5.08 (5.08)
d	-	-	-	-	184 (184)	7.24 (7.24)
e	-	-	-	-	163 (226)	6.42 (8.90)
f	-	-	-	-	100 (100)	3.94 (3.94)
g	-	-	-	-	155 (155)	6.10 (6.10)

Dimensions [mm]	PTFE Wave Horn	PP Wave Horn	Metallic Horn				Wave Guide
			DN80 / 3"	DN100 / 4"	DN150 / 6"	DN200 / 8"	
h	68	33	100 (220 for the HT extension) 1				
k	-	-	100, 200, 300, 400, 500, 1000 2				
m	296 3	322	112	148.5	223	335	1000...6000
Øp	43	43	80	100	140	200	30

1 The HT extension is only for Metallic Horn and Wave Guide antennas. It is attached between the signal converter and the flange if the process connection temperature is +150...+250°C.

2 These are the length options for the straight antenna extension. For data about the dimensions of "S" and "L" extensions, refer to the illustrations that follow.

3 Other antenna lengths are available: 396, 496 or 596 mm. These options are for tanks with long nozzles.

# FLEXIBLE ANTENNA EXTENSIONS

Dimensions [inches]	PTFE Wave Horn	PP Wave Horn	Metallic Horn				Wave Guide
			DN80 / 3"	DN100 / 4"	DN150 / 6"	DN200 / 8"	
h	2.68	1.30	3.94 (8.66 for the HT extension) 1				
k		-	- 3.94, 7.87, 11.81, 15.75, 19.68 or 39.37 2				
m	11.65 3	12.68	4.41	5.85	8.78	13.19	39.4...236.2
Øp	1.69	1.69	3.15	3.94	5.51	7.87	1.18

1. The HT extension is only for Metallic Horn and Wave Guide antennas. It is attached between the signal converter and the flange if the process connection temperature is +302...+482°F.

2. These are the length options for the straight antenna extension. For data about the dimensions of "S" and "L" extensions, refer to the illustrations that follow.

3. Other antenna lengths are available: 15.59", 19.53" or 23.46". These options are for tanks with long nozzles.

## FLEXIBLE ANTENNA EXTENSIONS

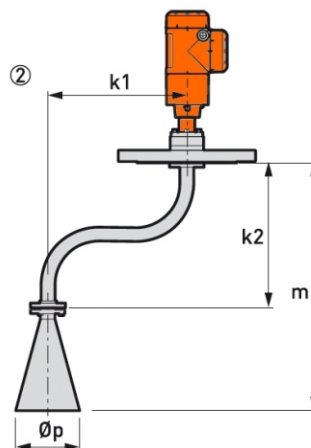
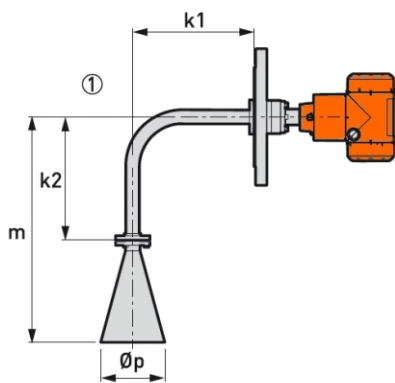

Special antenna extensions for tanks with obstructions inside please note these are suitable for DN150 / 6" and DN200 / 8" Metallic Horn antenna options only.

1. "L" (right angle) antenna extension
2. "S" antenna extension

Dimensions [mm]	Metallic Horn antenna			
	With "L" (right angle) extension		With "S" extension	
	DN150 / 6"	DN200 / 8"	DN150 / 6"	DN200 / 8"
k1			271	300
k2			271	322
m	494	606	545	657
Øp	140	200	140	200
Dimensions [inches]	Metallic Horn antenna			
	With "L" (right angle) extension		With "S" extension	
	DN150 / 6"	DN200 / 8"	DN150 / 6"	DN200 / 8"
k1			10.67	11.81
k2			10.67	12.68
m	19.45	23.86	21.46	25.87
Øp	5.51	7.87	5.51	7.87

# ANTENNA SELECTION GUIDE

The graphs below show which antenna to select for the application based on the measuring range and the dielectric constant of the product being measured ( $\epsilon_r$  is the dielectric)

## Metres

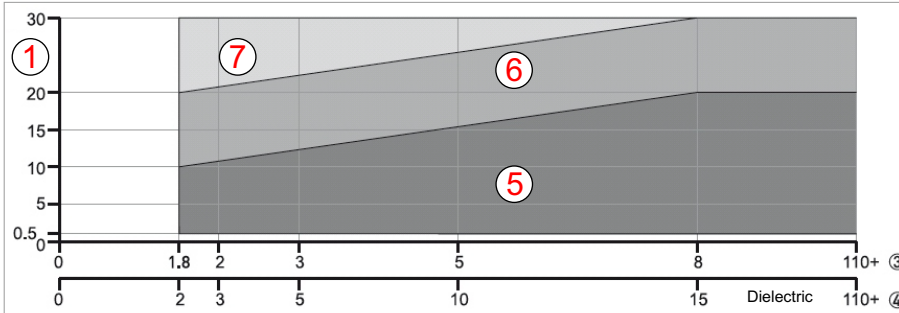

Figure 1-1: Selection of antenna (graph of distance in m against  $\epsilon_r$ )

## Feet

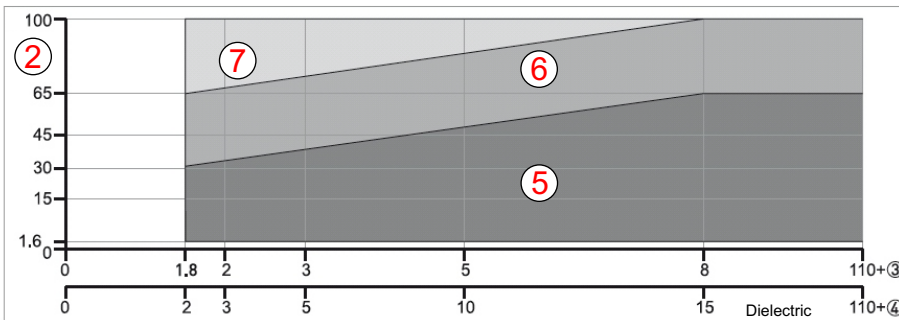

Figure 1-2 : Selection of antenna (graph of distance in ft / m against  $\epsilon_r$ )

- ① Tank height / Measuring range [m]
- ② Tank height / Measuring range [ft]
- ③ Dielectric ( $\epsilon_r$ ) for storage tanks with smooth product surface
- ④ Dielectric ( $\epsilon_r$ ) for process tanks without agitator or foam
- ⑤ All antennas:- DN80/3" and DN100/4" Metallic Horn antenna: only for use in a stilling well\*  
- Wave Guide antenna: maximum measuring range is 6 m / 19.68 ft
- ⑥ DN150/6" or DN200/8" Metallic Horn antennas in a stilling well\* or DN200/8" Metallic Horn antenna
- ⑦ DN200/8" Metallic Horn antenna in a stilling well\*

\*A stilling well is equivalent to the Wave Guide antenna option or a bypass chamber

# ADVANCED PLAUSIBILITY SOFTWARE

Many liquid and slurry applications have tank stirrers and obstructions mounted inside the tank for example tank support braces, ladders, inlet pipes and heater coils. Under normal monitoring conditions these obstructions can cause false signal tracking which can indicate problems such as full tanks when empty and the level not moving when indeed the tank is emptying.

To remove these obstacles from the level measurement information Hycontrol deploy a software routine called **'Empty Tank Spectrum'** or ETS for short.

Utilising this software enables accurate and reliable level readings to be taken even on complex internal tank structures

## A. EMPTY TANK SPECTRUM

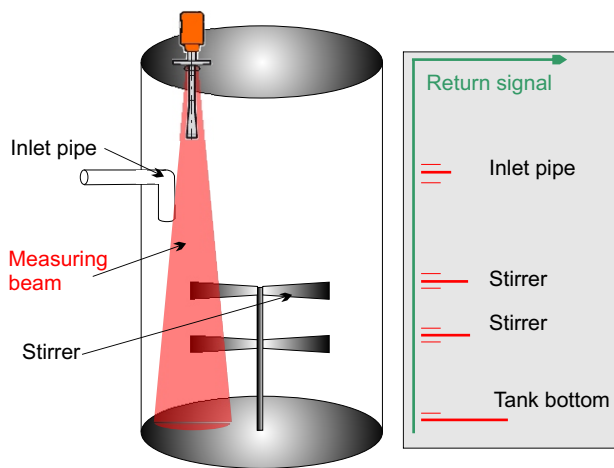

The ETS scans the complete vessel for all obstructions to identify potential problems

## B. MEASUREMENT SPECTRUM

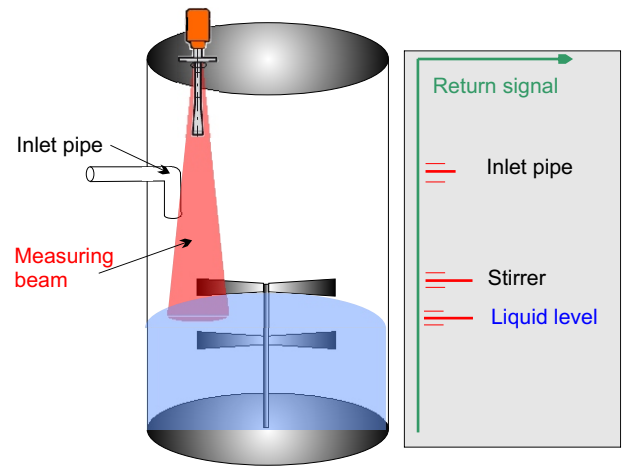

This is where the radar combines all the signals before applying the plausibility algorithm

## C. CORRECTED SPECTRUM

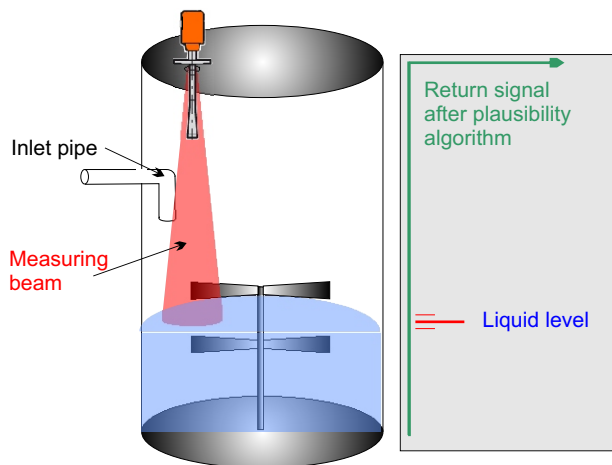

The corrected spectrum differentiates between the true level and spurious signals

This ETS algorithm is able to scan the tank when the vessel is empty and analyse all of the return signals but it is important there is no product in the tank at all to uncover all of the obstacles that may be present when the tank is nearly empty.

These signals are then stored to memory and recalled when monitoring the vessel so the software can then remove the false returns while monitoring the tank levels.

The diagrams opposite show a typical empty tank along with the typical return signals generated (see diagram A for Empty spectrum). The tank is then filled with product and a measurement spectrum is taken (see diagram B).

A complex plausibility algorithm is then run and the corrected spectrum is then produced which the level output is then based on. This system is simple to carry out and only needs to be done at commissioning stage.



# TECHNICAL SPECIFICATION

Measuring principle	2-wire loop-powered level transmitter; X-band (10 GHz) FMCW radar	
Application range	Level measurement of liquids, pastes and slurries	
Primary measured value	Distance and reflection	
Secondary measured value	Level, volume, mass and flow rate	

## Design

Construction	The measurement system consists of a measuring sensor (antenna) and a signal converter
Options	<p>Integrated LCD display (-20...+60°C/ -4...+140°F); if the ambient temperature is not in these limits, the display switches off automatically</p> <p>High-temperature (HT) extension (if the process connection temperature is more than +150°C / +302°F - Metallic Horn antenna only)</p> <p>Straight antenna extensions Max. extension length, PTFE Wave Horn antenna: 300 mm / 11.8"; Max. extension length, Metallic Horn antenna: 1000 mm / 39.4"</p> <p>"S" antenna extension - only for DN150/6" and DN200/8" Metallic Horn antenna options</p> <p>"L" (right angle) antenna extension - only for DN150/6" and DN200/8" Metallic Horn antenna options</p> <p>Antenna purging system - only for DN150/6" and DN200/8" Metallic Horn antenna options</p> <p>Heating / cooling system (with or without the antenna purging system) - only for DN150/6" and DN200/8" Metallic Horn antenna options</p> <p>Signal cable for remote housing version (refer to cable properties in "Electrical connection: Remote device version")</p> <p>Weather protection - for the compact version or the antenna housing (remote version). It cannot be ordered after delivery of the device.</p>
Max. measuring range	<p>PTFE and PP Wave Horn antennas: 20 m / 65.6 ft</p> <p>DN80 / DN100 Metallic Horn antennas (installation only in stilling wells): 10 m / 32.8 ft</p> <p>DN150 / DN200 Metallic Horn antennas: 30 m / 98.4 ft</p> <p>Wave Guide antenna: 6m/ 32.8 ft</p> <p>Also depends on the dielectric constant of the product and the installation type. Refer also to "Antenna selection".</p>
Min. tank height	1m/ 3.3 ft
Top dead zone	Minimum value: Antenna length + antennna extension length + 100 mm / 3.9"

## Technical data

Beam angle (½ angle) of antenna	PP Wave Horn: 10°
	PTFE Wave Horn: 10°
	Metallic Horn DN80 / 3": 16° - used only in stilling wells
	Metallic Horn DN100 / 4": 12° - used only in stilling wells
	Metallic Horn DN150 / 6": 8°
	Metallic Horn DN200 / 8": 6°
	Wave Guide / stilling well: n/a - the radar signal is inside the tube.
Display and user interface	
Display	LCD display
	128 × 64 pixels in 8-step greyscale with 4-button keypad
Interface languages	<p>3 language pack options (the language is given in the customer order):</p> <p>1 English, French German and Italian</p> <p>2 English, French, Spanish and Portuguese</p> <p>3 English, Chinese (Mandarin), Japanese and Russian</p>

# ACCURACY

Resolution	1 mm/ 0.04"
Repeatability	±1 mm/ ±0.04"
Accuracy	Standard: ±10 mm / ±0.4", when distance < 10 m / 33 ft; ±0.1% of measured distance, when distance > 10 m / 33 ft Option: ±5 mm/ ±0.2", when distance < 10 m / 33 ft; ±0.05% of measured distance, when distance > 10m/ 33 ft
Reference conditions acc. to EN 61298-1	
Temperature	+15...+25°C / +59...+77°F
Pressure	1013 mbara ±50 mbar / 14.69 psia ±0.73 psi
Relative air humidity	60% ±15%
Target	Metal plate in an anechoic chamber

## Operating conditions

Temperature	
Ambient temperature	-40...+80°C/ -40...+176°F Ex: see supplementary operating instructions or approval certificates
Storage temperature	-50...+85°C/ -58...+185°F
Process connection temperature (higher temperature on request)	PP Wave Horn antenna: -20...+100°C / -4...+212°F
	PTFE Wave Horn antenna: -50...+150°C / -58...+302°F
	Metallic Horn antenna / Wave Guide antenna: Standard: FKM/FPM (-40...+150°C (+200°C with an HT extension) / -40...+302°F (+392°F with an HT extension)); Options: Kalrez® 6375 (-20...+150°C (+250°C with an HT extension) / -4...+302°F (+482°F with an HT extension)); PFA (-60°C...+130°C/ -76...+266°F); EPDM (- 50...+130°C / -58...+266°F)The process connection temperature must agree with the temperature limits of the gasket material. Ex: see supplementary operating instructions or approval certificates 1

## Operating conditions

Process pressure	PP Wave Horn antenna: -1...16 barg / -14.5...232 psig. For more data, refer to Pressure ratings on page 18.
	PTFE Wave Horn antenna: -1...40 barg / -14.5...580 psig. For more data, refer to Pressure ratings on page 18.
	Metallic Horn antenna / Wave Guide antenna: Standard: -1...40 barg / -14.5...580 psig; subject to the process connection used and the flange temperature. Higher pressure on request.
Purging system (option)	Max. 6 barg / 87 psig (higher pressure on request)
Heating / cooling system (option)	Max. 6 barg / 87 psig (higher pressure on request)
Other conditions	
Dielectric constant ( $\epsilon_r$ )	Direct mode: ≥1.8 TBF mode: ≥1.1 Refer also to "Technical data: Antenna selection".
	IEC 60529: IP 66/67 NEMA 250: NEMA type 4X (housing) and type 6P (antenna)
Maximum rate of change	10 m/min / 32.8 ft/min
Installation conditions	
Process connection size	The nominal diameter (DN) should be equal to or larger than the antenna diameter.
Process connection position	Make sure that there are not any obstructions directly below the process connection for the device. For more data, refer to Installation on page 31.
Dimensions and weights	For dimensions and weights data, refer to Dimensions and weights on page 24.

# TECHNICAL SPECIFICATION

Housing	Standard: Polyester-coated aluminium
	Option: Stainless steel (1.4404 / 316L)
Antenna options / Wetted materials	PTFE Wave Horn antenna with a PTFE flange cladding
	PP Wave Horn antenna with a PP jacket/threaded process connection
	Stainless steel (1.4404 / 316L) Metallic Horn antenna with a PTFE process seal and an FKM/FPM, EPDM, Kalrez® 6375 or PFA O-ring gasket
	Stainless steel (1.4404 / 316L) Wave Guide antennas with a PTFE process seal and an FKM/FPM, EPDM, Kalrez® 6375 or PFA O-ring gasket
Feedthrough	PP Wave Horn antenna: this is a single-piece antenna (the feedthrough is filled with PP)
	PTFE Wave Horn antenna: this is a single-piece antenna (the feedthrough is filled with PTFE)
	Metallic Horn and Wave Guide antennas: Dual process seal system - 1st seal: PTFE with O-ring gasket , 2nd seal: Metaglas® with O-ring gasket 2
Cable gland	Standard: none
	Options: Plastic (Non-Ex: black, Ex i-approved: blue); nickel-plated brass; stainless steel
Weather protection (Option)	Stainless steel (1.4404 / 316L)

## Process connections

Thread	PP Wave Horn antenna: G 1½; 1½ NPT
Flange version	
EN	PTFE Wave Horn antenna: DN50...150 in PN16, PN40
	Metallic Horn and Wave Guide antennas: DN80...200 in PN16, PN40; others on request
ASME	PTFE Wave Horn antenna: 2"...6" in 150 lb / 300 lb
	Metallic Horn and Wave Guide antennas: 3"...8" in 150 lb / 300 lb; others on request
JIS	PTFE Wave Horn antenna: 50...150A in 10K
	Metallic Horn and Wave Guide antennas: 80...200A in 10K; others on request
Other	Others on request

## Electrical supply

Power supply	Terminals output - Non-Ex/ Ex i: 12...30 VDC; min./max. value for an output of 22 mA at the terminal
	Terminals output - Ex d: 16...36 VDC; min./max. value for an output of 22 mA at the terminal
Maximum current	22 mA
Current output load	Non-Ex / Ex i: $R_L [\Omega] \leq ((U_{ext} - 12 V) / 22 \text{ mA})$ . For more data, refer to Minimum power supply voltage on page 17.
	Ex d: $R_L [\Omega] \leq ((U_{ext} - 16 V) / 22 \text{ mA})$ . For more data, refer to Minimum power supply voltage on page 17.
Cable entry	Standard: M20×1.5; Option: ½ NPT
Cable gland	Standard: none
	Options: M20×1.5 (cable diameter: 6...10 mm / 0.2...0.39"); others are available on request
Cable entry capacity (terminal)	0.5...2.5 mm <sup>2</sup>

## Output signal

Output signal	4...20 mA HART® or 3.8...20.5 mA acc. to NAMUR NE 43 <sup>3</sup>
Resolution	±3 µA
Temperature drift	Typically 50 ppm/K
Digital temperature drift	Max. ±15 mm / 0.6" for the full temperature range
Error signal	High: 22 mA; Low: 3.6 mA acc. to NAMUR NE 43

# ACCURACY

CE	This device fulfils the statutory requirements of the EC directives. The manufacturer certifies successful testing of the product by applying the CE mark.
Vibration resistance	EN 60068-2-64 Metallic Horn (without antenna extension options): 5 Hz to 100 Hz: 4g Metallic Horn, PTFE or PP Wave Horn: 3.5 mm up to 8 Hz and 10 m/s <sup>2</sup> : 1g, 8.5 to 2000 Hz
Explosion protection	
ATEX DEKRA 11ATEX0166 X	II 1/2 G, 2 G Ex ia IIC T6...T2 Ga/Gb or Ex ia IIC T6...T2 Gb;
	II 1/2 D, 2 D Ex ia IIIC T90°C Da/Db or Ex ia IIIC T90°C Db IP6X;
	II 1/2 G, 2 G Ex d ia IIC T6...T2 Ga/Gb or Ex d ia IIC T6...T2 Gb;
	II 1/2 D, 2 D Ex ia tb IIIC T90°C Da/Db or Ex ia tb IIIC T90°C Db IP6X
IECEX IECEX DEK 11.0060 X	Ex ia IIC T6...T2 Ga/Gb or Ex ia IIC T6...T2 Gb;
	Ex ia IIIC T90°C Da/Db or Ex ia IIIC T90°C Db IP6X;
	Ex d ia IIC T6...T2 or Ex d ia IIC T6...T2 Gb;
	Ex ia tb IIIC T90°C Da/Db or Ex ia tb IIIC T90°C IP6X
cFMus - Dual Seal-approved	NEC 500
	XP-IS / Cl. I / Div. 1 / Gr. ABCD / T6;
	DIP / Cl. II/III / Div. 1 / Gr. EFG / T6;
	IS / Cl. I/II/III / Div. 1 / Gr. ABCDEFG / T6;
	NI / Cl. I / Div. 2 / Gr. ABCD / T6
	NEC 505
	Cl. I / Zone 0 / AEx d [ia] / IIC / T6;
	Cl. I / Zone 0 / AEx ia / IIC / T6;
	Cl. I / Zone 2 / AEx nA [ia] / IIC / T6;
	Hazardous (Classified) Locations, indoor/outdoor Type 4X and 6P, IP66, Dual Seal
	CEC Section 18 (Zone ratings)
	Cl. I, Zone 1, Ex d, IIC (Antenna: Zone 0), T6;
	Cl. I, Zone 0, Ex ia, IIC, T6;
	Cl. I, Zone 2, Ex nA, IIC, T6 DIP A21 IP66 TB 95°C
CEC Section 18 and Annex J (Division ratings)	
Cl. I, Div. 1/2, Gr. ABCD; Cl. II, Gr. EFG; Cl. III, T6;	
NEPSI (pending)	Ex ia IIC T2~T6 DIP A21 TA IP66;
	Ex d ia IIC T2~T6 DIP A21 TA IP66
INMETRO (pending)	Ex ia IIC T6...T2 Ga/Gb
	Ex ia IIIC T90°C Da/Db IP6X
	Ex d [ia Da] IIC T6...T2 Ga/Gb
	Ex tb [ia Da] IIIC T90°C Db IP6X

1. If the process connection temperature is more than 150°C / 302°F and the device has Kalrez® 6375 or FKM/FPM gaskets, the device will also have an high temperature extension between the converter and the process connection. Kalrez® is a registered trademark of DuPont Performance Elastomers L.L.C. The process connection temperature must agree with the temperature limits of the gasket material.

2. Metaglas® is a registered trademark of Herberts Industrieglas, GMBH & Co., KG

3. HART® is a registered trademark of the HART Communication Foundation

# TECHNICAL SPECIFICATION

SIL	Compact version only: SIL 2 - according to EN 61508 and for high/low demand mode operation
EMC	Electromagnetic Compatibility Directive 2004/108/EC in conjunction with EN 61326-1 (2006) SIL 2-approved devices agree with EN 61326-3-1 (2008) and EN 61326-3-2 (2008)
Radio approvals	R & TTE Radio Equipment and Telecommunications Terminal Equipment Directive 1999/5/EC in conjunction with ESTI EN 302 372 (2006) FCC Rules Part 15 Industry Canada RSS-210
LVD	Low-Voltage Directive 2006/95/EC in conjunction with EN 61010-1 (2001)
NAMUR	NAMUR NE 21 Electromagnetic Compatibility (EMC) of Industrial Process and Laboratory Control Equipment NAMUR NE 43 Standardization of the Signal Level for the Failure Information of Digital Transmitters NAMUR NE 53 Software and Hardware of Field Devices and Signal Processing Devices with Digital Electronics NAMUR NE 107 Self-Monitoring and Diagnosis of Field Devices
CRN	This certification is applicable for all Canadian provinces and territories. For more data, refer to the website.
Construction code	Metallic Horn and Wave Guide antennas: NACE MR0175 / ISO 15156; NACE MR0103

# HYCONTROL LEVEL TECHNOLOGIES

## Product Range For Solids :-

- (1) TDR Radar For Solids
- (2) Ultrasonic, 'Through Air'
- (2) 2 Wire Ultrasonic Transmitter
- (3) FMCW 2 Wire Radar
- (4) Continuous 'Servo' Level Indicator
- (5) FMCW 2 Wire Radar
- (6) Capacitance Level Switch
- (7) Vibrating Probe Level Switch
- (8) Rotating Paddle Level switch
- (9) Microwave Level Switch
- (10) Doppler Flow Switch

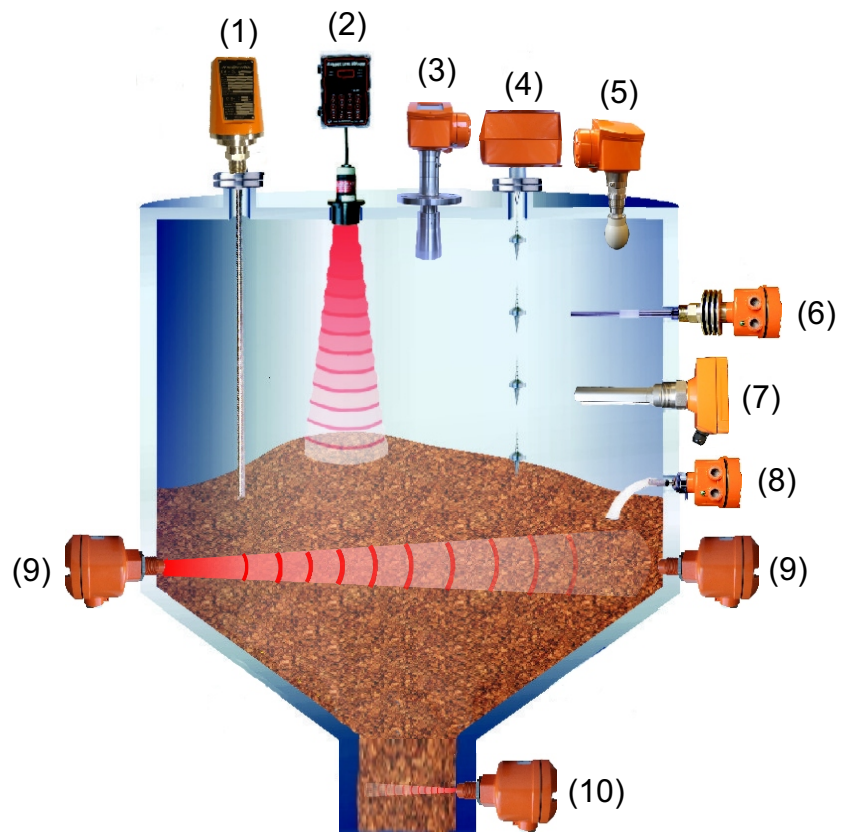

## Product Range For Liquids :-

- (1) By-Pass Level Indicator With Radar
- (2) TDR Radar For Liquids
- (3) 2 Wire Ultrasonic Transmitter
- (4) FMCW 'Horn' Radar 2 Wire
- (5) Magnetic Float Switches
- (6) FMCW 2 Wire Radar
- (7) Capacitance Level Switch
- (8) RF Admittance Level Switch
- (9) Side Mounting 316 SS Float Switch
- (10) Tuning Fork Level Switch
- (11) Tuning Fork Level Switch
- (12) Ultrasonics 'Through Wall'
- (13) Mini Magnetic Float Level Switch

